

Regionalizácia v DVB-T2 už na úrovni jednotlivých SFN

Ing. et Bc. Jakub Juhas

Čo je cieľom

- Umožniť vznik nového obchodného modelu
- Ponúknuť hlbšiu regionalizáciu
- Optimalizovať požiadavky na počet pridelených frekvencií

Požiadavky:

- SFN Synchronizácia
- DVB-T2
- Multi PLP network
- Rovnaké nastavenie PLP
v rámci jednej SFN

Multi Frequency Network:

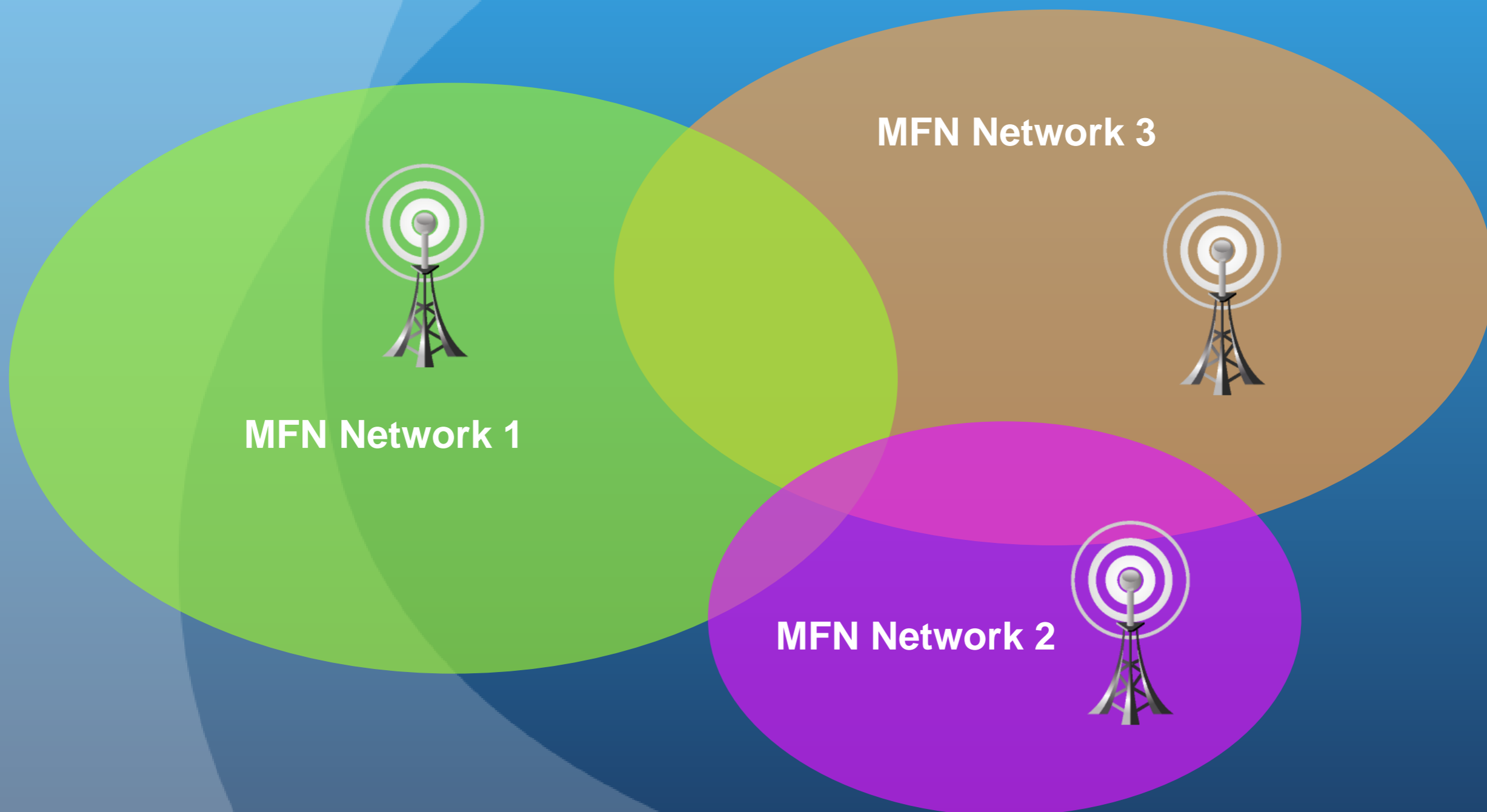

Single Frequency Network:



SFN Network 1



DVB-T2 Data:

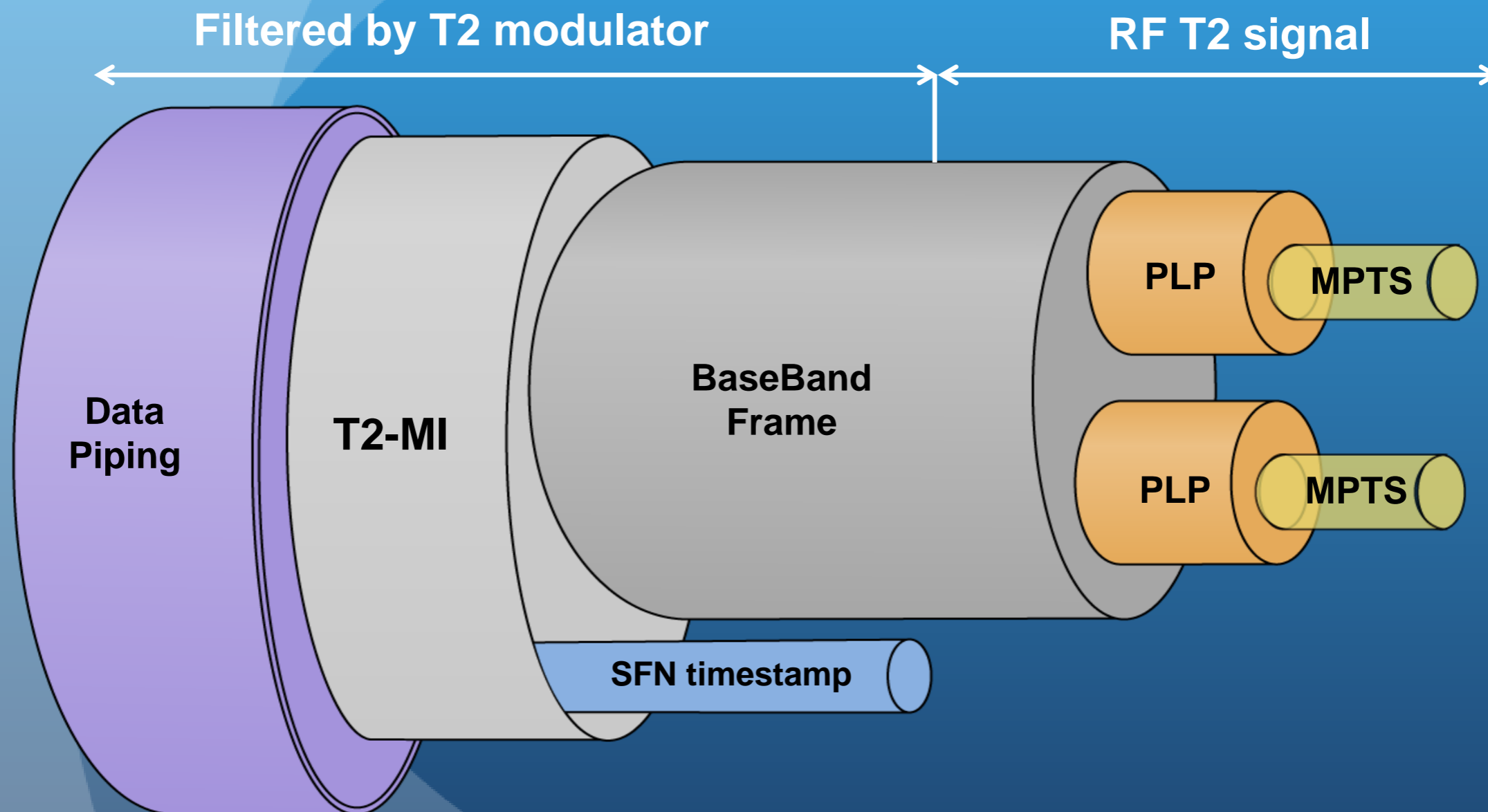

DVB-T2: Multi PLP

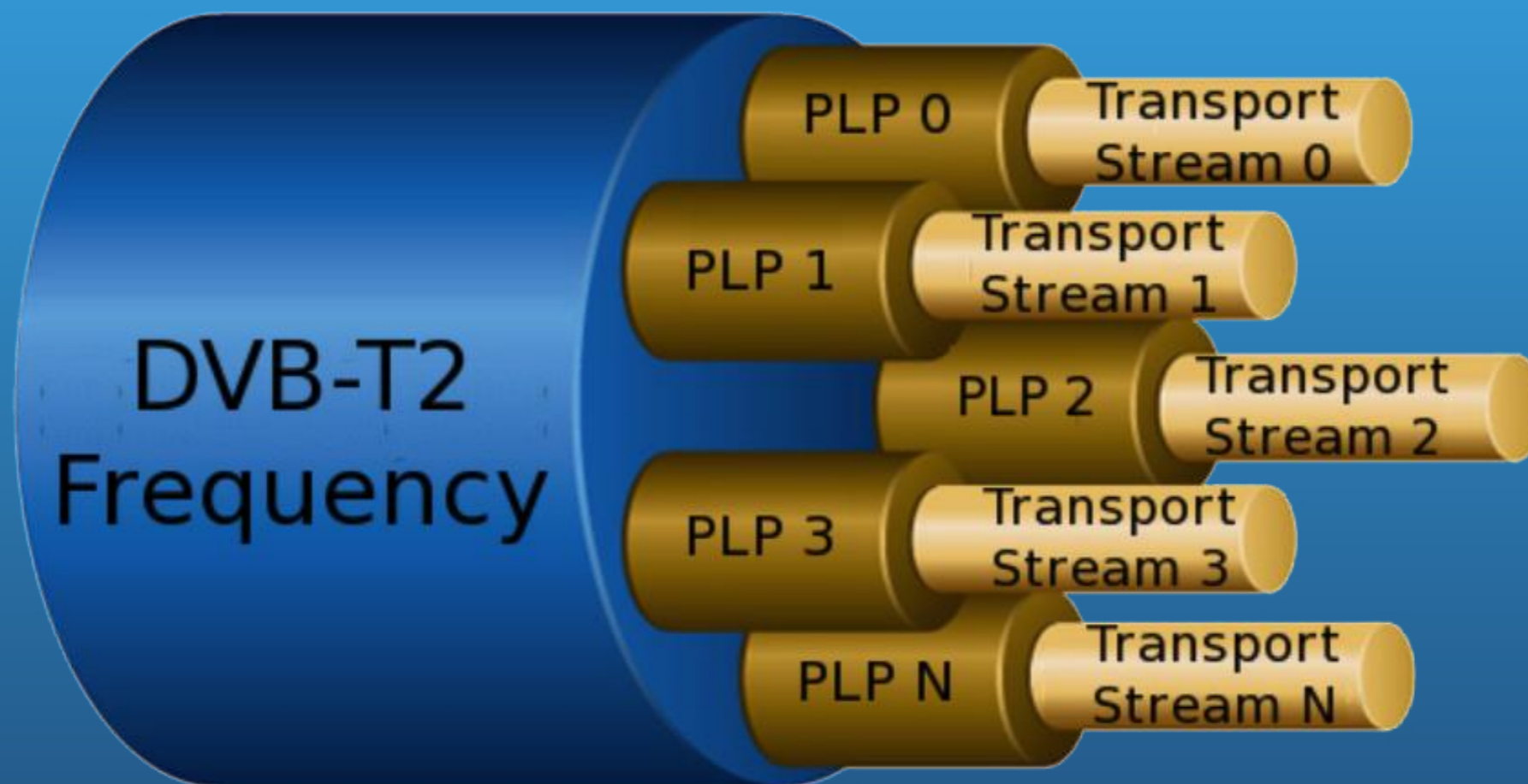

DVB-T2: T2 Frame

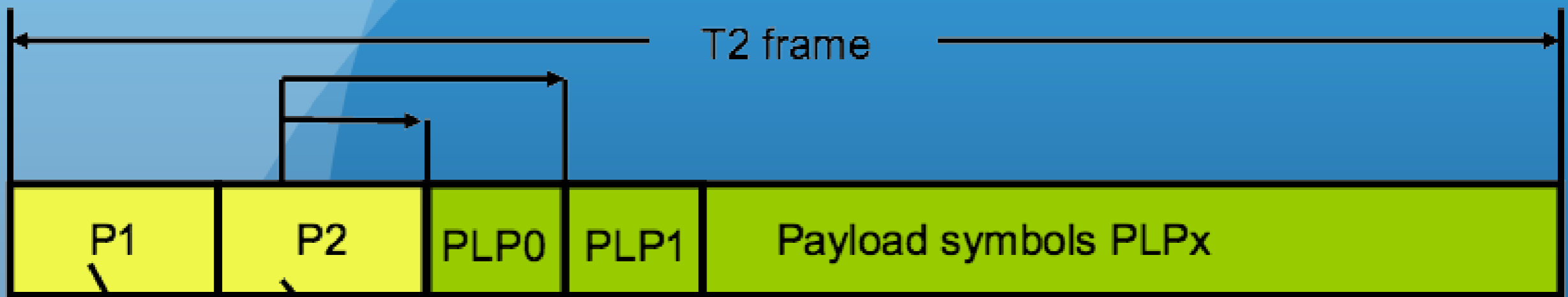

P2 symbols containing signalling data

P1 symbol for synchronization and frame detection

Rovnaké Parametre a PLP

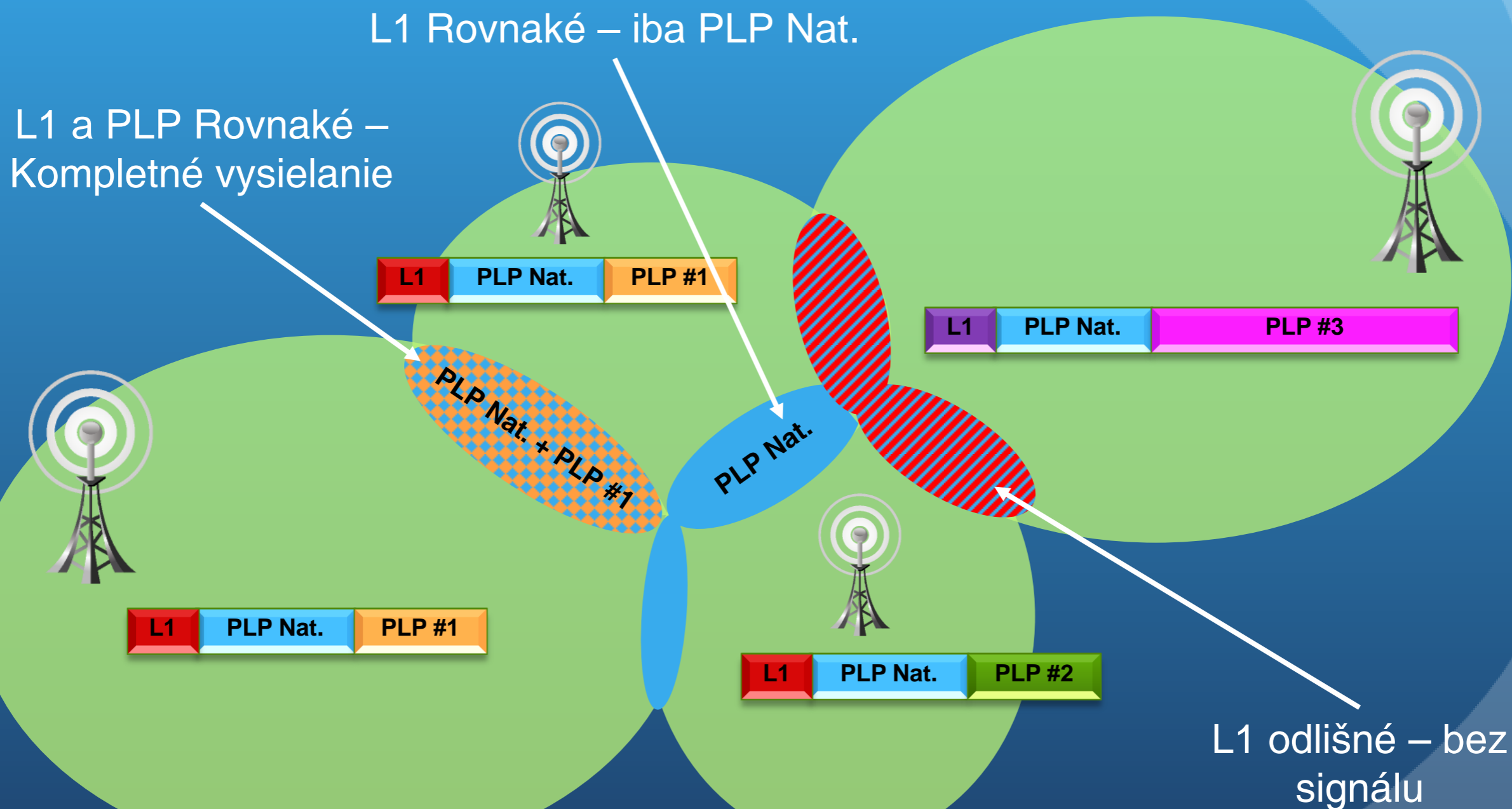

DVB-T2: Multi PLP

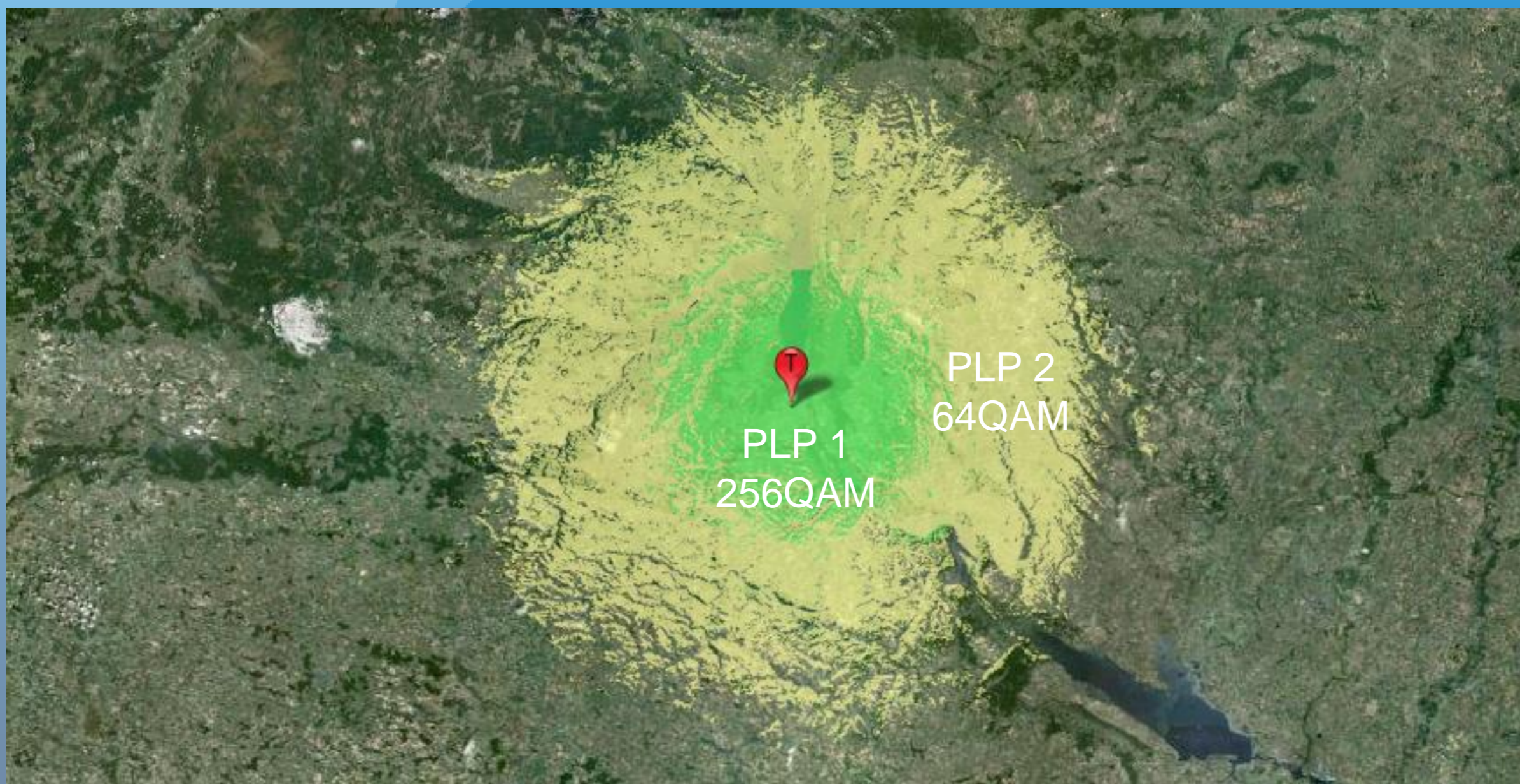

DVB-T2: Multi PLP + SFN

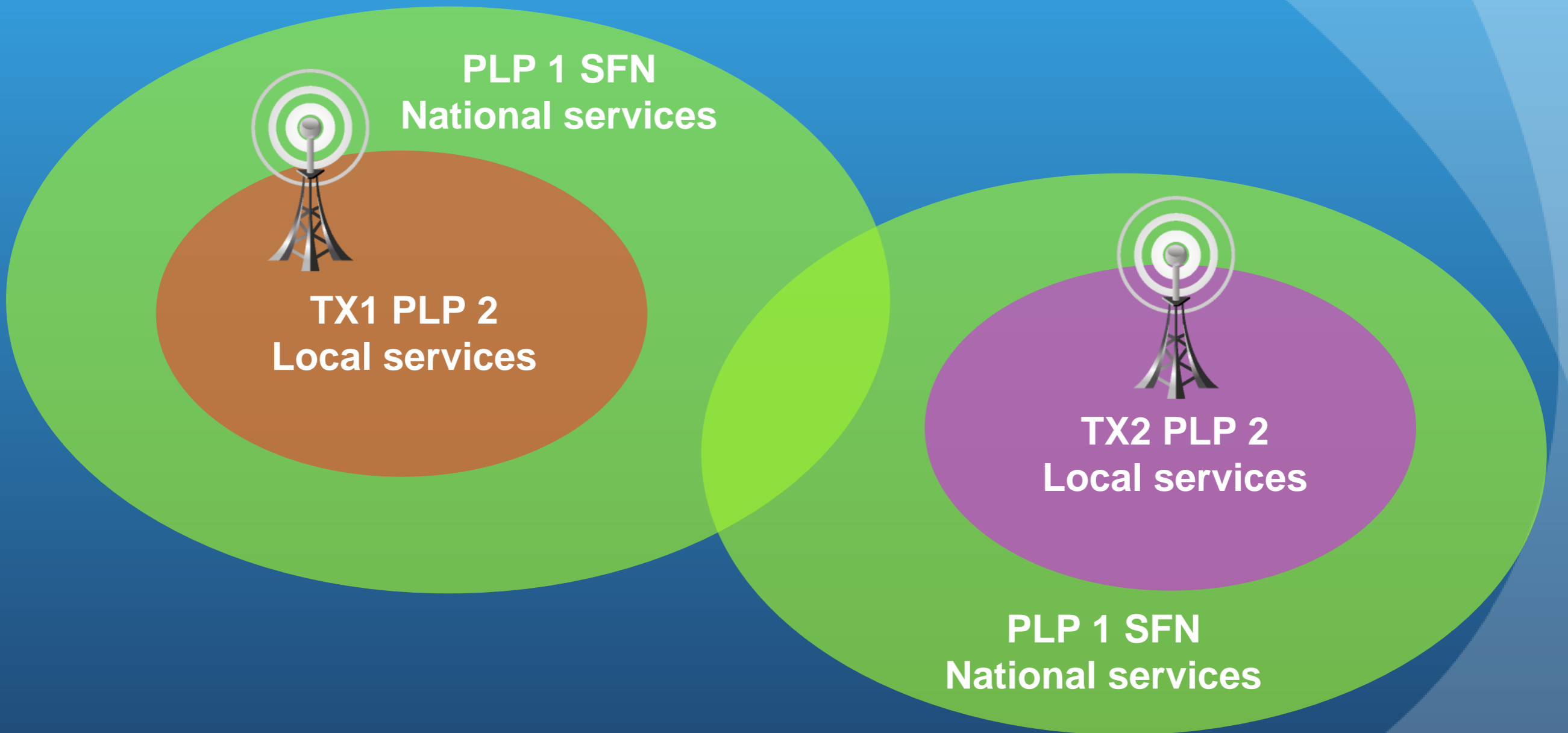

Regionalizácia v rámci 1 SFN

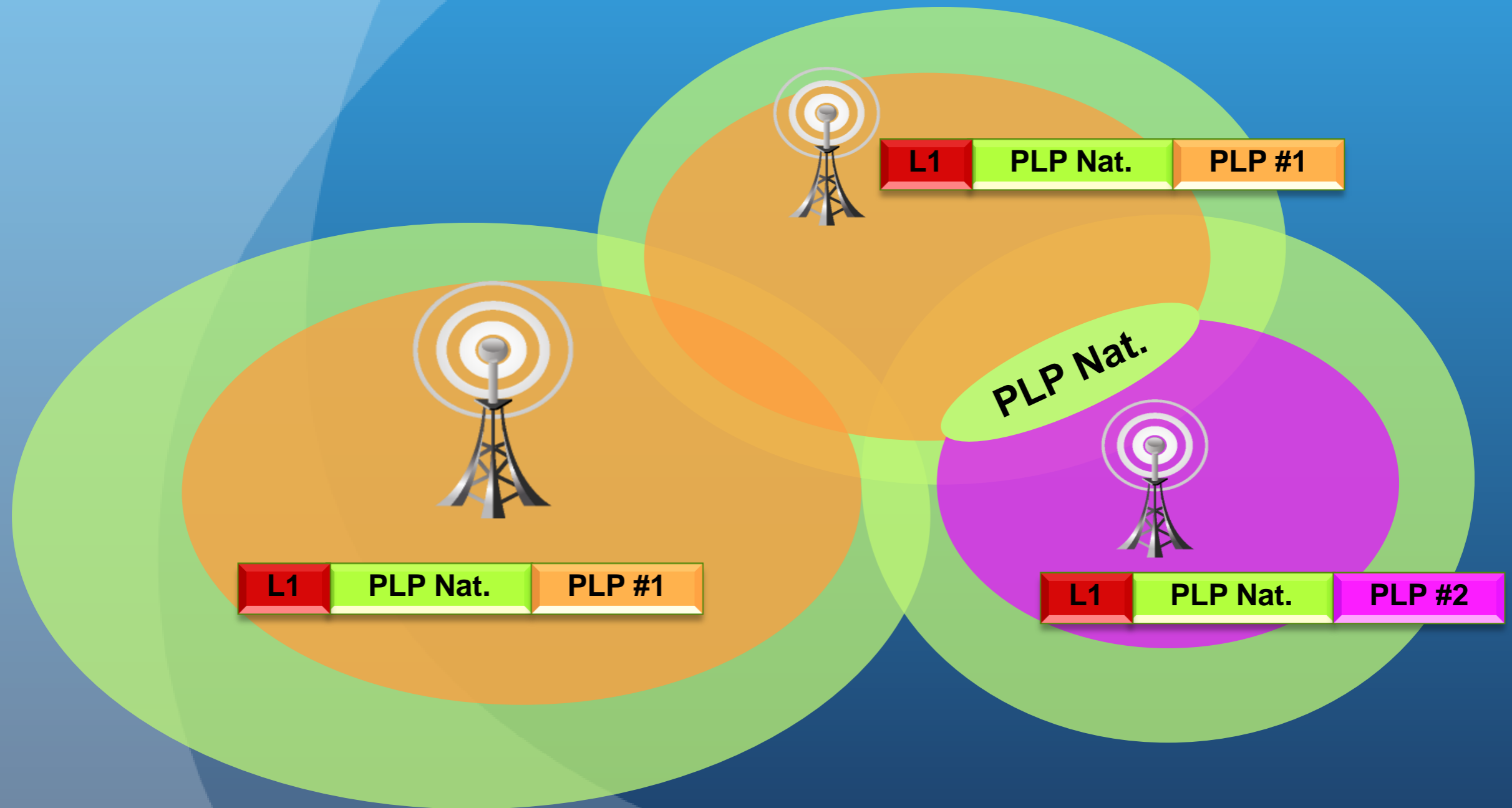

Dá sa ísť hlbšie

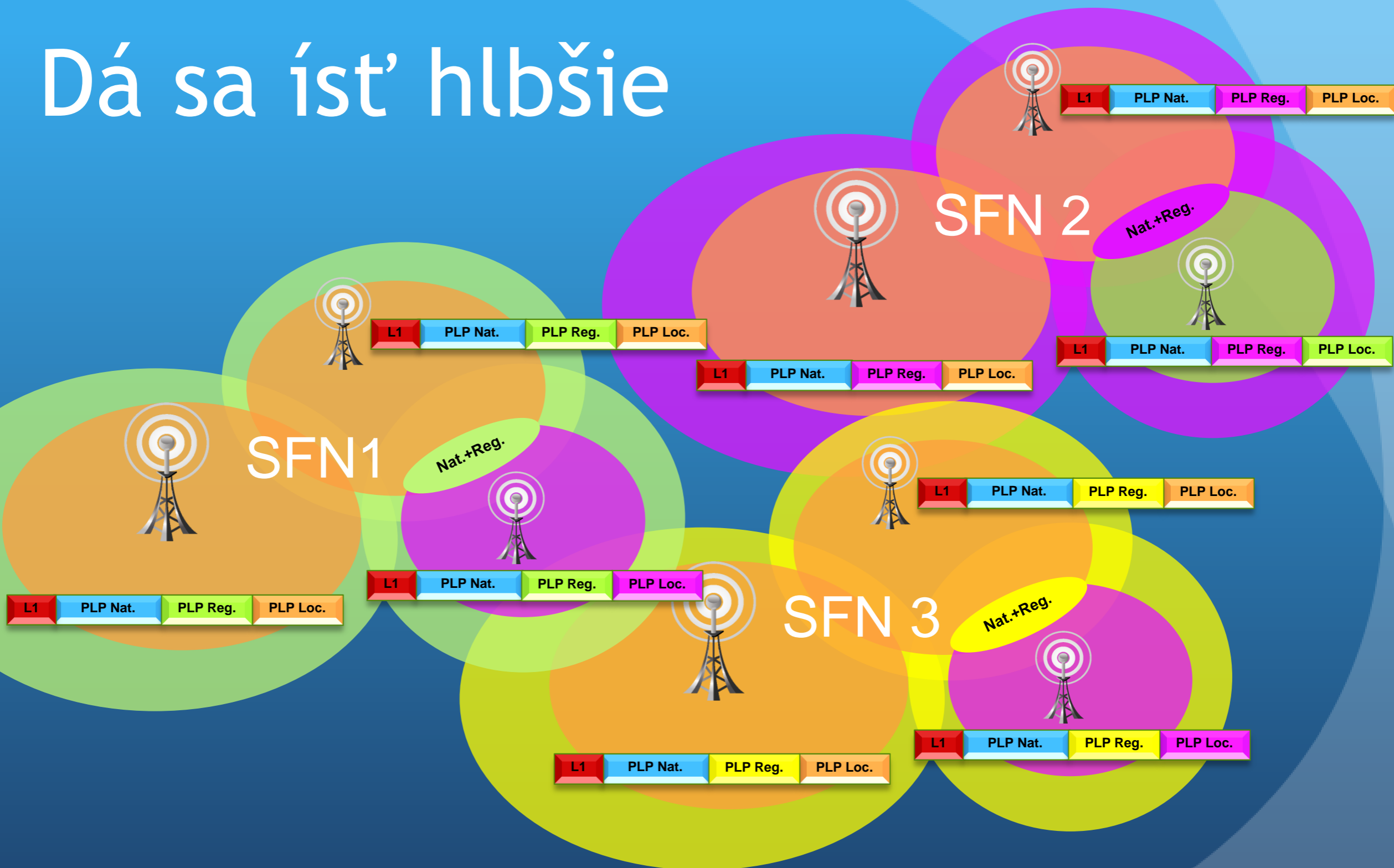

Ďakujem za pozornost'

Ing. et Bc. Jakub Juhas
juhas@multiplex4.cz
<http://www.multiplex4.cz/>